

Zenith® Pumps Spin Finish Series Gear Pumps

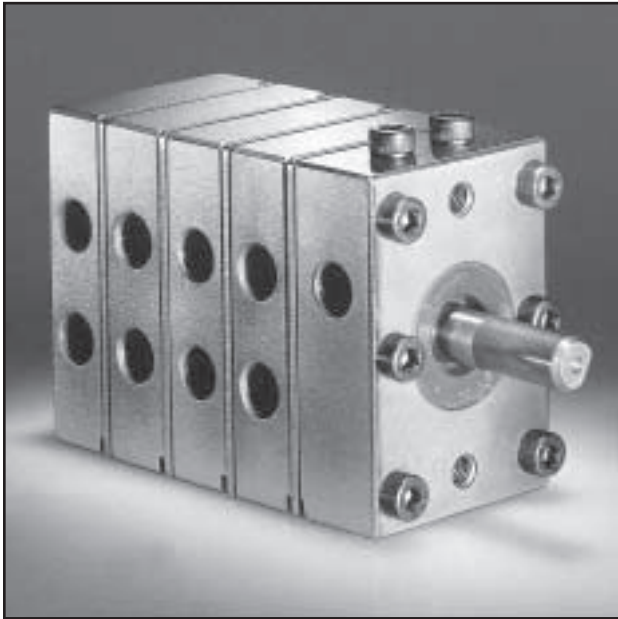

Installation, Care
And Maintenance

Zenith Finish
Metering Applications

Thoroughly read and understand this entire manual before installation and operation of pump

Zenith® Pumps

For more than 70 years, Zenith® Pumps has provided the synthetic fiber industry with precise, pulseless and repeatable gear metering pumps. From the earliest applications in viscose and hot-melt fiber spinning, through the more recent applications in high performance, specialty fiber spinning, Zenith has met the challenges of the fiber industry with pumps of unmatched performance and quality.

In virtually every stage of the synthetic manufacturing process, today's fiber producers throughout the world rely on Zenith pumps to accurately

meter polymer and fluid flows. In continuous polymerization plants, Zenith pumps accurately transport pre-polymer fluids to and from reactor vessels. In melt polymer extrusion lines, Zenith pumps supply additives and boost polymer pressures feeding spin beams. In yarn, staple and nonwoven lines, Zenith spin pumps meter polymers to spinnerets for precise denier control; and, prior to winding, Zenith spin finish pumps and systems accurately deliver yarn finishes to spun fibers to ensure optimum winding and textile processability.

Benefits

High Accuracy

Stable and repeatable flows are assured even under varying conditions of temperature, viscosity, and pressure.

Minimum Pulsation

Unique design offers virtually pulseless flow without valves or flexible elements to hinder performance.

Precision Construction

Ground and lapped components allow for close control of operating clearances.

High Volumetric Efficiency

Maximum efficiency is achieved with minimal operating clearances.

Corrosion Resistance

400 series stainless steel provides good bearing qualities and the necessary corrosion resistance for most standard finishing chemicals.

Maximum Life

Only four moving parts per gear plate; components are through hardened to HRc 54 or better.

Specifications

Pump Type:	Rotary external spur gear, multiple stream.
Rotation:	Refer to pump drawing.
Operating Speed:	5-120 rpm depending upon application conditions and fluid viscosity (typically 10-60 rpm).
Temperature:	To 300° F (150° C) maximum. A heat jacket may be required for above ambient temperatures.
Viscosity:	1 to 100 cps.
Pressure Rating:	Flooded suction pressure required, 7 psi maximum. Differential pressure should be near zero.

Design

Zenith spin finish metering pumps are constructed from high grade stainless steels. The side, gear, and port plates are 420 modified and the gears, shafts, and arbors are 440-C. The pumps consist of three or more gears rotating in mesh within a closely fitted housing. The center, or gear plate, fits closely around the outside diameter of the metering gears. The front, rear, middle and/or intermediate plates sandwich the center plate and restrict axial movement of the gears.

In the spin finish pump, the gear set is comprised of a driving gear and two driven gears per gear plate. In all series, the driving gear is keyed to the drive shaft while the driven gears rotate on stationary arbors.

The standard spin finish pumps have a lip seal design. A Buna-N lip seal with stainless steel spring is chemically inert to most chemicals and is commonly used for general purpose metering in a variety of applications.

Operation

Fluid enters the pump through a port located in the front side plate. The fluid fills the exposed gear tooth cavities and is transported around the outer diameter of the gear pocket. As the gears mesh together, the fluid is displaced out through the discharge ports of the middle and/or intermediate plates. Because the pumps are manufactured with precision tolerances and minimal gear clearances, extremely high volumetric efficiencies can be achieved.

Zenith gear pumps are not self-priming and therefore require a flooded suction at the pumps inlet port. However, when high viscosity fluids are pumped, more time is required to fill the tooth cavities. As a result, the inlet pressure must be increased or the gears must rotate at a slower speed to ensure complete volume filling and to prevent cavitation.

Zenith pumps rely on the metered fluid for lubrication of internal bearing areas. The pump should never be allowed to run dry or be allowed to run with non-lubricating fluids such as water or solvent. Because of very small bearing clearances, lack of sufficient lubrication can cause the pump to seize and possibly experience catastrophic failure.

Slip can occur across the sides of the gears from the high-pressure side to the low-pressure side of the pump. The amount of slip depends on four factors: fluid viscosity, speed, differential pressure and pump clearances. Under reasonably stable operating conditions, slip is repeatable and predictable, and pump operation can be adjusted to compensate.

Zenith spin finish pumps are designed for low temperature operation and low pressure applications. The maximum operating temperature should not exceed 300° F and differential pressure should be kept near zero. When operating at temperatures above ambient, heat jackets should be used and pumps should be heated slowly and uniformly.

The 400 series stainless steels used in the construction of the spin finish pumps provides sufficient corrosion resistance for most standard chemical processes. The hardness of the pump materials (54 HRc) will provide a certain degree of wear resistance as well. However, processes involving corrosive or abrasive fluids should always be verified with the factory.

Installation

Pumps should be carefully unpacked to make sure shipment is complete. If any items were damaged during shipment, the freight carrier and Zenith Pumps should be notified immediately.

Zenith Pumps are shipped filled with a rust preventative oil. If necessary, flush the pump thoroughly with a cleaning solvent turning by hand. It may be necessary to disassemble the seal arrangement to remove all traces of oil. Disassemble only if necessary.

Prior to start-up, the pump must be lubricated by either priming the pump with the process fluid, or by pouring a suitable lubricant into the inlet port. Rotate the drive shaft until lubricant appears at the discharge port.

The following is a brief "standard" installation procedure for Zenith spin finish metering pumps. For any special applications, considerations, or technical assistance, please contact our Applications Engineering Group.

To prepare the pump for use:

1. Always flush the plumbing system prior to connecting the pump.

2. Filters should be installed upstream of the pump inlet port. The filter should ideally be sized to one half of the pump gear clearances.

3. Turn pumps by hand before running. Pumps should turn freely.

4. Fixed mount pumps should be installed on an L-shaped saddle or mounting block and mounting screws must be secure. (Do not install with radial or axial loads on the pump drive shaft. This will adversely affect the life of the pump.)

5. Make sure that fluid is in the pump before starting. Apply positive pressure to the pump inlet when metering high viscosity fluids.

6. Start the pump slowly and, if possible, break-in with a lubricating fluid.

7. When satisfactory operation is achieved, the pump and system can be gradually brought up to normal operating speed.

8. If, at any time during operation, the pump does not appear to be running smoothly, stop the pump immediately to avoid serious internal damage.

Cleaning, Inspection and Repair

Zenith spin finish metering pumps are made for exacting duty. All parts are machined to extreme accuracy. Critical dimensions are held between one and two ten-thousandths of an inch (.0001"/.0002"). Accurate performance is dependent upon proper handling. Please handle the pumps with extreme care, and if possible, set aside a separate clean area for pump maintenance and repair.

It is recommended that pump users institute a program for dimensional inspection of critical parts in order to keep maintenance and operating costs to a minimum. By noting the performance of a pump immediately before removing it from service and correlating the performance to measured component wear, the user

can establish maximum wear limits for the pump's critical components. Further, the service life of the pump can be predicted and downtime can be scheduled accordingly.

As with any other Zenith pump, Spin Finish Series pumps may be returned to Zenith for complete rehabilitation. For a large number of pumps, Zenith offers a contract repair service which helps to reduce repair costs and delivery time. Zenith Pumps also offers pump maintenance seminars, repair video tapes, and installation, care, and maintenance manuals. For more information concerning Zenith pump repair services, please contact our customer service department.

Lapping or Blocking

To remove nicks, burrs and scour marks from pump parts, place two layers of 400 Grit Emery Cloth on a lapping block or plate—a granite flat is also suitable. Apply light pressure to the part and turn it using a figure 8 motion as shown in Figure 1 approximately 10 times until a smooth finish appears. Components that are commonly lapped are metering gear sides, and the inside faces of front, rear, center, middle and/or intermediate plates. After lapping is completed the parts are ready to be cleaned. An ultrasonic cleaner with a safe industrial solvent (Nu solution) is preferred, but a large container filled with solvent to approximately 4 inches deep can be used.

CAUTION: Never drop the components into a tank or container; place them gently onto the bottom to avoid damage.

Always use clean, lint free rags, and compressed air to clean components. Paper towels are not acceptable because they can leave small pieces of paper dust on the pump parts. Use chemical brushes to clean between gear teeth, bores, and relief grooves. After all components are “hospital clean”, the pump is ready for assembly.

New and replacement parts should always be deburred and cleaned using the above procedures.

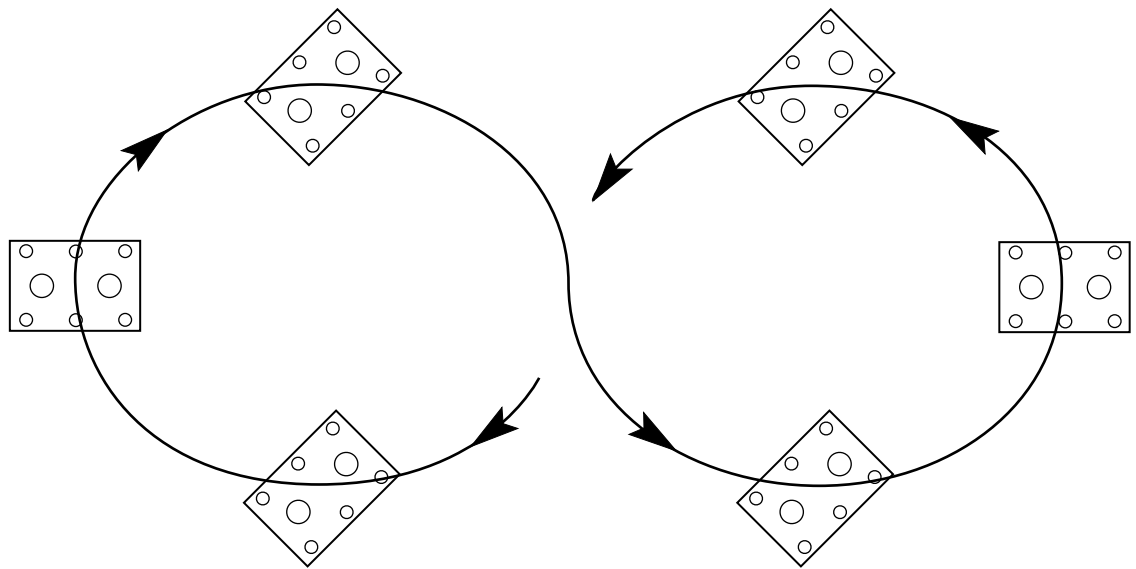

Figure 1

Note: Part should be rotated by quarter turns as it moves through a “figure 8” pattern

Spin Finish Series Disassembly

Refer to Diagrams beginning on page 8 (general reference only).

NOTE: As parts are disassembled, place them carefully on a clean surface such as a soft cloth. Do not allow them to knock together. Pay close attention to the order in which parts are removed. This will aide in the assembly of the pump.

1. Place the pump in a soft jaw bench vise with the drive shaft facing upward.
2. Remove the binder screws which clamp the pump plates together.
3. Remove the front plate by lifting upwards sliding the plate over the drive shaft until clear. It may be necessary to gently tap the plates with a rubber mallet in order to separate them from each other.
4. Gently remove the gear plate in the same direction. Do not attempt to force or pry the gear plate from the gears as possible damage may occur.

CAUTION: Do not allow the metering gears to be lifted out with the gear plate. They may drop, causing damage to the gear teeth.

5. Remove the driven gears from the arbors.
 6. Remove the driving gear by sliding it up and over the drive shaft.
 7. Remove the drive shaft key.
 8. Remove the intermediate or middle plate noting the orientation for reassembly.
 9. Repeat procedures 4-8 until all gear, intermediate and or middle plates have been removed.
 10. Remove the drive shaft from rear plate.
 11. Press arbors from the rear, intermediate and or middle plates using the shortest path of resistance.
 12. Remove the lip seal from the front plate by gently placing a screwdriver in the ID of the seal and pry the seal from the plate.
-

Reassembly

Considerable care should be taken to prevent wedging or jamming. Never force the parts together. They will drop into place if properly aligned.

1. Provide a can of clean oil, preferably SAE-50 motor oil or mineral oil.

2. Press Arbors into intermediate, middle and/or rear plates as required using the driven metering gear as a guide for pressing the arbor upright and perpendicular to the plate.

3. Press a new lip seal (by hand) into the counterbore of the front side plate with the open area of the seal facing the inside of the pump.

4. Clamp the rear plate in a soft jaw bench vise with the inside surface facing upwards.

5. Lubricate the drive shaft bearing holes and arbors with a few drops of oil.

6. Install the drive shaft into the rear side plate.

7. Place the drive shaft key into the keyway located along the drive shaft.

8. Install the driving gear by sliding it down the drive shaft and over the key until it rests on the plate.

9. With a thin film of oil on your fingertips, lubricate the I.D. of the gear pockets in the gear plate. Place the gear plate over the driving gear and onto the plate. Be certain to install the gear plate in the same position as it had been prior to disassembly.

10. Install the driven gears (insert over arbors in rear plate if equipped). Check for free rotation of the gear set.

11. Place a drop of oil into each port location and rotate the drive shaft several times to ensure free rotation.

12. Place the intermediate plate onto the gear plate and locate the arbors with the I. D. of the driven gears. Be certain to install the plates in the same position as they were prior to disassembly.

13. Repeat steps 6-12 until all plates have been properly reinstalled.

Note: If the pump will not turn freely after each component is installed, then the last piece installed needs additional attention or replacement.

14. Replace the front side plate by gently placing the I.D. of the lip seal over the O.D. of the drive shaft. Carefully slide the plate and seal down the shaft until it touches the last gear plate. The lip seal has no cover plate and may pop out during this procedure. If this occurs, simply repeat the same procedure.

15. Install binder screws and torque to 50% of rated capacity using a crossing pattern. Check for free rotation of the gears. If acceptable, continue to torque to full load of bolt rating. Again, check for free rotation of the gears.

Spin Finish Series

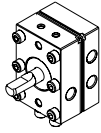

Zenith 2 Stream Spin Finish Pump

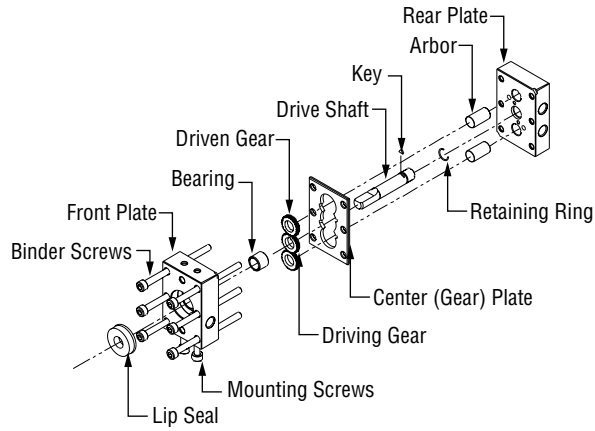
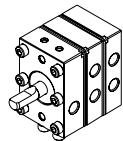

Diagram 1



Zenith 4 Stream Spin Finish Pump

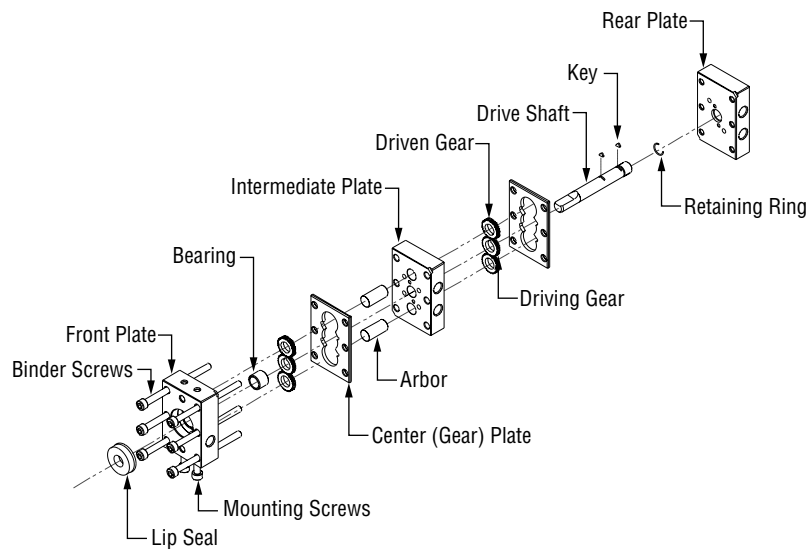

Diagram 2

Spin Finish Series (cont.)

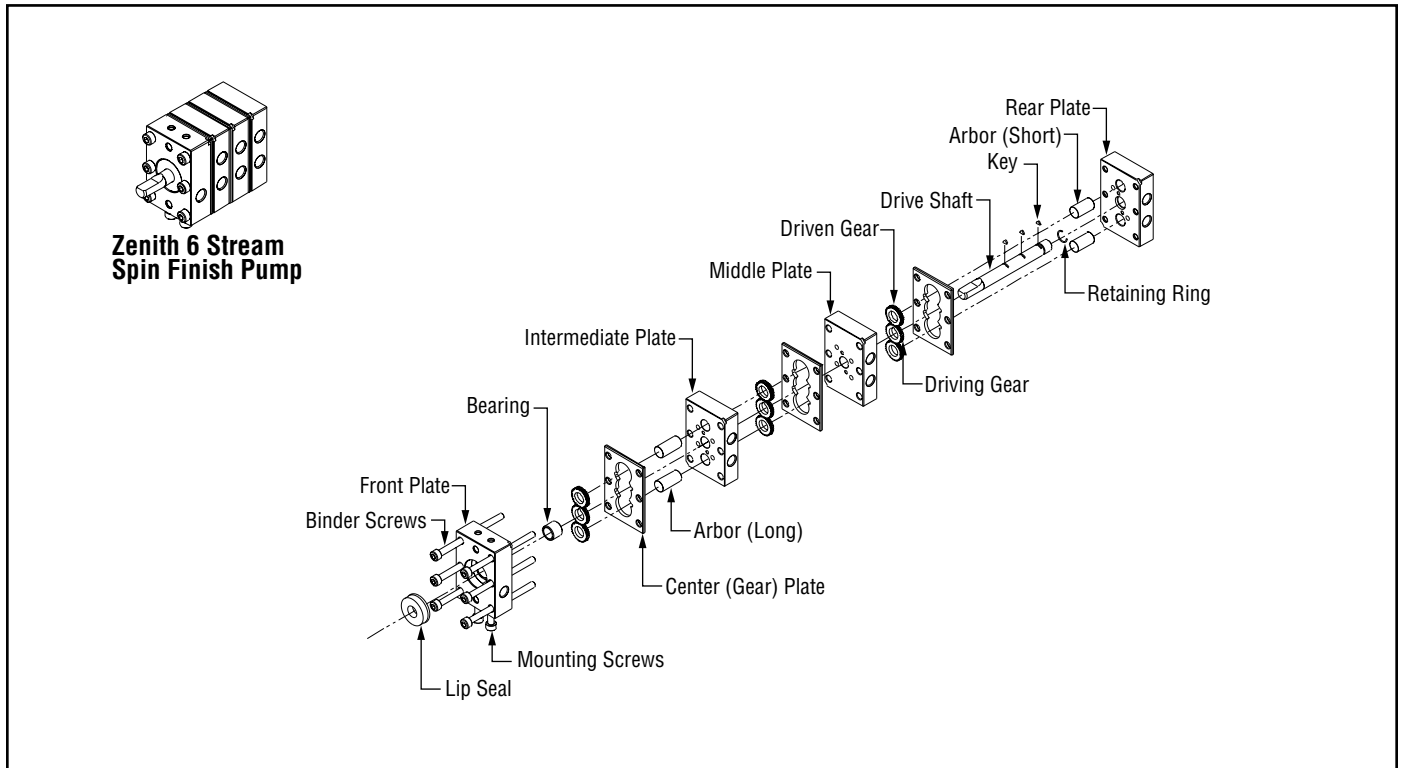

Diagram 3

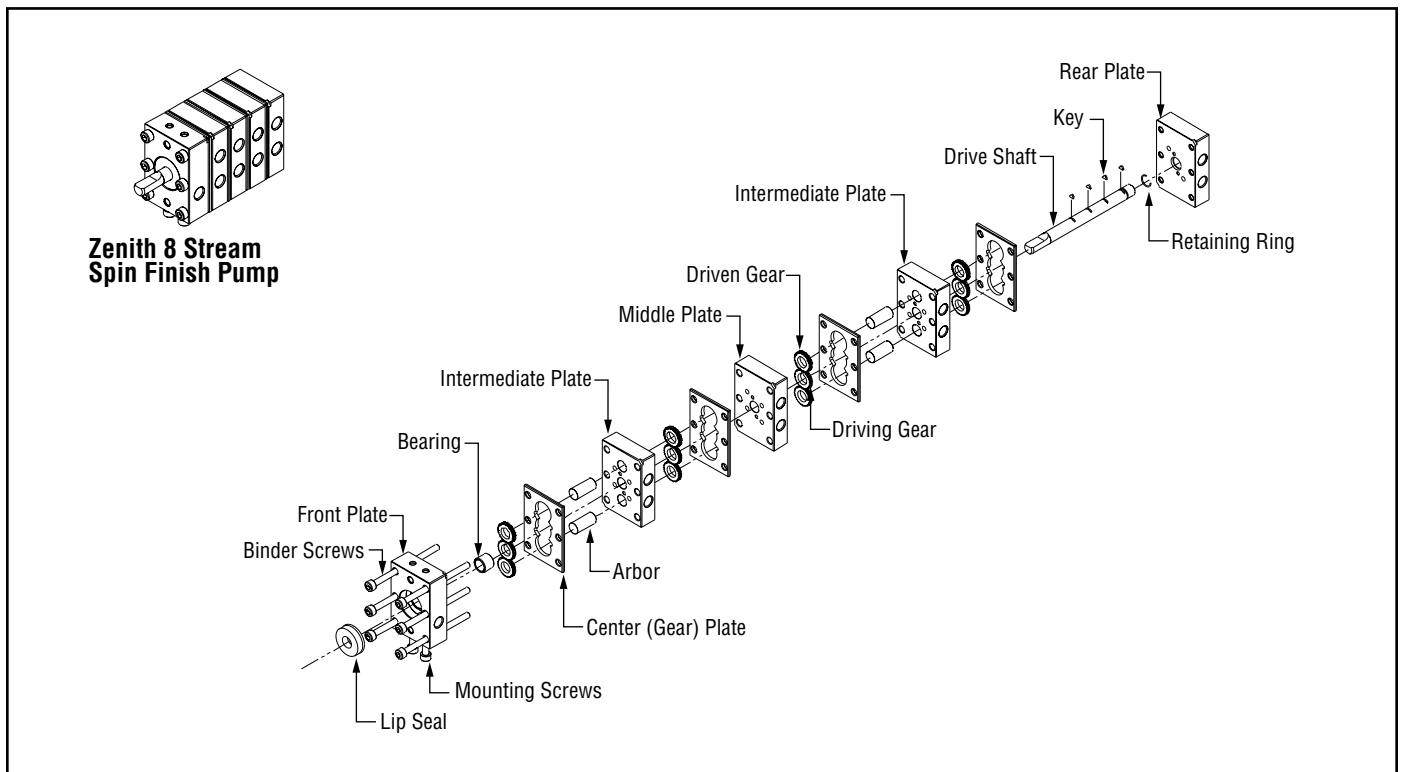

Diagram 4

Spin Finish Series (cont.)

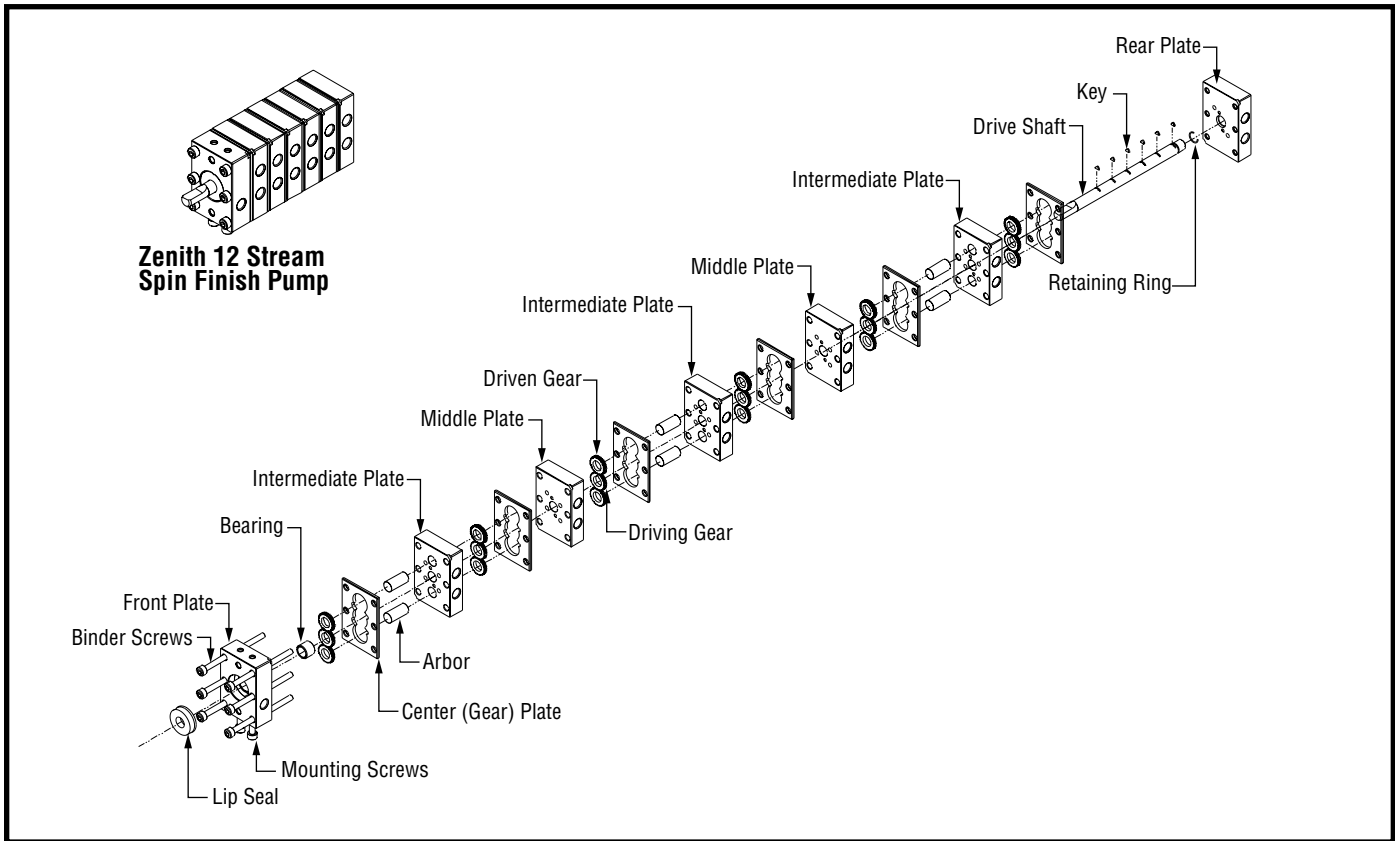

Diagram 5

Bolt Torque

Size (UNC Alloy Steel)

Recommended Torque (lbs.-in.)
(Based on lubricated threads)

M5

56

M6

96

Troubleshooting

Trouble	Probable Cause	Remedy
Pump will not turn	1) Drive malfunction	Verify power to drive. Check to assure all alarm circuits are clear. Check drive motor current and speed settings.
	2) Process conditions changed	Check process conditions for proper temperature, pressures, viscosities and materials.
	3) Entrained particle	Disassemble and clean pump, replace any damaged parts.
	4) Possible internal damage	Disassemble and clean pump, replace any damaged parts.
Excessive seal leakage	1) Worn lip seal	Replace lip seal.
	2) Scored drive shaft	Replace drive shaft if necessary
Reduced pump efficiency	1) Worn gears	Replace worn gears
	2) Worn bearings	Replace worn bearings
	3) Process conditions changed	Consult factory for gear clearance recommendations for new process conditions.



WARNING

FAILURE, IMPROPER SELECTION OR IMPROPER USE OF THE PRODUCTS AND/OR SYSTEMS DESCRIBED HEREIN OR RELATED ITEMS CAN CAUSE DEATH, PERSONAL INJURY AND PROPERTY DAMAGE.

This document and other information from Zenith Pumps, its subsidiaries and authorized distributors provide product and/or system options for further investigation by users having technical expertise. It is important that you analyze all aspects of your application and review the information concerning the product or system in the current product catalog. Due to the variety of operating conditions and applications for these products or systems, the user, through its own analysis and testing, is solely responsible for making the final selection of the products and systems and assuring that all performance, safety and warning requirements of the application are met.

The products described herein, including without limitation, product features, specifications, designs, availability and pricing, are subject to change by Zenith Pumps and its subsidiaries at any time without notice.

ISO 9001: 2000 Registered



A Colfax Business Unit

Zenith® Pumps

1710 Airport Road
Monroe, NC 28110

Phone: 704-289-6511 • Fax: 704-289-9273

zenithpumps@colfaxcorp.com • www.zenithpumps.com

© Copyright 1996 Zenith Pumps SF-C&M 10/04