

Zenith® Pumps H-9000 Gear Pumps

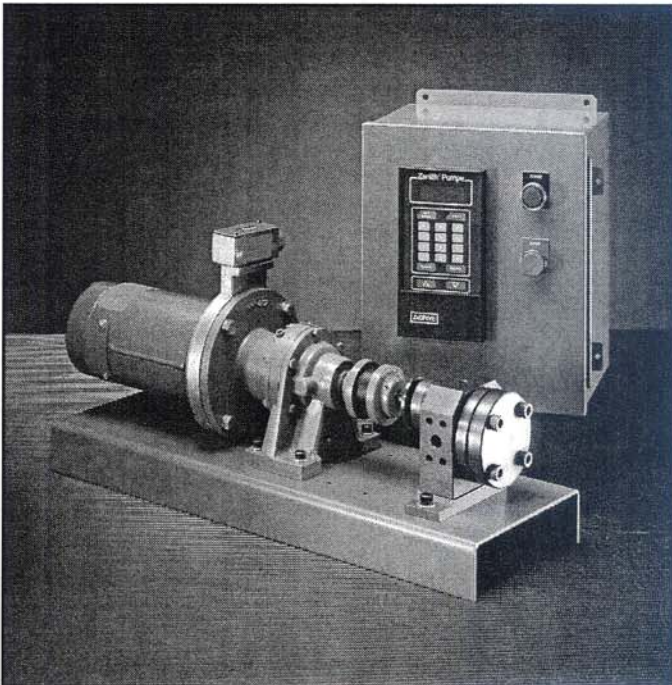

Installation,
Care and
Maintenance

Zenith®
Chemical Duty
Gear Pumps

Zenith®
Pumps

Thoroughly read and understand this entire manual before installation and operation of the pump.

Zenith Pumps

In 1926, Zenith Pumps was approached by the synthetic fiber industry to design a pump that would provide a precise, pulseless, repeatable flow while ensuring ultimate product quality. The options then were the same as those in the chemical process industry today – diaphragm, lobe, coarse gear, piston, plunger and screw pumps. Each has problems with pulsation, flow inaccuracies, multiple seal areas and slip, which require constant calibration, high maintenance and extended downtimes.

Zenith Pumps met the challenge and designed a rotary external gear

pump of unique precision and simplicity. Manufacturing techniques were developed to hold tolerances to $\pm .00005$ ", minimizing internal clearances and assuring accurate and precise metering. The pump's simplistic design of only three moving parts – two metering gears and a drive shaft – provided long life and reduced maintenance.

For years, engineers have relied on Zenith Pumps to provide precision fluid handling solutions for their most difficult pumping applications. Zenith gear pumps can be found wherever precise, pulseless, and repeatable metering of fluids is required.

Benefits

High Accuracy

Stable, repeatable flows are assured even under varying conditions of temperature, viscosity and pressure.

Precision Construction

Ground and lapped components allow for operating clearances to $.00015$ " and provide high volumetric efficiency.

Minimum Pulsation

Unique design offers virtually pulseless flow without valves or flexible elements to hinder performance.

Active Flowmeter Concept

Unparalleled mechanical precision, combined with the closed loop set

point accuracy, ensures an exact volume per revolution without expensive flow meters.

Low Cost of Ownership

With only three moving parts and tool steel construction, the pump provides excellent wear resistance for high temperature applications and is through-hardened to 62 Rc or better for maximum life.

Experience

Zenith has over 70 years of application experience with engineers available 24 hours a day to support your precision fluid metering needs.

Specifications

Pump Type: Precision ground rotary external spur gear with combination mechanical face and packing seal

Rotation: Clockwise, facing drive shaft

Operating Speed: 300 rpm maximum

Viscosity: 100,000 cps maximum

Temperature: 950°F (510°C) maximum

Inlet Pressure: 1,000 psi maximum (70 Bar)

Outlet Pressure: 1,000 psi maximum (70 Bar)

Design

Zenith's H-9000 Series precision metering pumps utilize a rotary external spur gear which dispenses an exacting volume of fluid per shaft revolution (cc/rev).

Precision ground and lapped construction, including alignment dowels, allows for close control of operating clearances. This ensures precise, pulseless and repeatable flow under varying process conditions.

Integrated closed loop speed control and a compact motor driver system maintains .01% accuracy of set point speeds and also accepts automated interfaces.

The H-9000 Series is constructed of tool steels, providing excellent bear-

ing qualities (hardness 62 Rc) as well as high temperature (950°F) and abrasion resistant capabilities. The pump offers increased uptime while minimizing maintenance due to its simple design of only three moving parts.

The H-9000 Series is a new generation of Zenith's traditional H-Series pump. While maintaining precise flow characteristics, its optimum gear design reduces bearing loads, while increasing speed capability. The pump allows direct piping and shaft engagement and includes a combination mechanical face and stuffing box shaft seal.

Operation

Fluid enters the pump through the inlet port located in the front plate and fills the gear pocket. As the gears rotate, a precise amount of fluid is trapped by the side walls of the gear pockets and gear teeth.

The metered fluid is transported by the rotation of the gears to the discharge side of the pump where the gear teeth come into mesh. This action forces the fluid out of the gear teeth and through the outlet port located in the front plate. The pressure developed is determined by the pump size, the gear clearances, pump speed, fluid viscosity and impedance to flow.

Pump speed is limited by practical considerations. If a high viscosity fluid is being metered and pump speed is increased beyond a certain point, the fluid may not be able to fill the gear teeth spaces, and the pump will not obtain enough fluid to maintain normal volumetric efficiency. Lack of sufficient fluid is called starvation or cavitation. This can be remedied by increasing the inlet pressure or reducing pump speed.

Metering of thin fluids requires a different approach. Since the pump depends upon the metered fluid for lubrication of internal bearing surfaces, speeds are normally limited. These bearing surfaces include the bearing areas in the front and rear plates, and the driven gear turning about the arbor. Accelerated wear and even seizure maybe the result of high

speeds, especially if attended by low lubricity or a fluid containing abrasive particles. In certain applications, it is recommended to use a pump of larger capacity operated at a lower speed. Contact our Applications Engineering Department for assistance.

Pump efficiency depends on four basic variables: fluid viscosity, gear clearances, differential pressure and pump speed. The less viscous the fluid, the more likely it is to flow through a given orifice. In a Zenith Pump, this orifice is the gear clearance. Differential pressure forces the fluid through this clearance at a steady rate, regardless of the pump speed. Thus, the slip is constant for a given amount of time. The actual delivery of fluid is the measured delivery minus the slip. If we increase the pump speed we increase the measured delivery, while the slip remains constant, causing the pump to become more efficient. Likewise, if we slow the pump down, the pump becomes less efficient. Slip is repeatable and predictable, and pump operation can be adjusted to compensate and, thus, accuracy is very high.

Zenith H-9000 Series pumps are designed for high-temperature operation. As such, operating temperatures to 950°F can be achieved. When operating at temperatures above ambient, heat jackets should be used, and pumps should be heated slowly and uniformly to avoid warpage and internal component interference.

Installation

Pumps should be carefully unpacked and checked to make sure that the shipment is complete. If any items are missing or damaged, the freight carrier and Zenith should be notified immediately.

While the pump is composed of tool steel, it is a precision instrument. Dropping or hitting the pump with a non-yielding material can cause serious damage to the components. All materials are through-hardened to maximum hardness resulting in brittle material. **Treat them as you would any other precision gaging instrument.**

It is not recommended to flush downstream process equipment utilizing Zenith precision metering pumps. Most fluids used as flushing agents, such as solvents and water, have a low viscosity and have poor lubricating qualities.

Catastrophic failure **may** occur under certain operating conditions. If it is necessary to flush the system, the following suggestions are recommended to prevent premature pump failure:

1. If possible, flush the system using a lubricating fluid.
2. Minimize the differential pressure across the pump ports to 25 psi.
3. Reduce the pump speed to an acceptable level (approximately 10 rpm).
4. Flush the pump for the shortest allowable time, yielding effective cleansing of the system, and no longer than necessary.
5. It is recommended to use a bypass around the pump as illustrated in Figure A. This will allow for high velocity flushing of the system while minimizing risk to the metering

Figure A

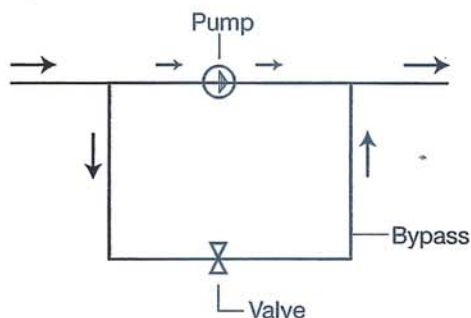

pump. During the flush cycle, fluid will pass through and around the pump. This will allow the system to be flushed quickly and effectively.

To prepare the pump for use:

1. Zenith pumps are coated inside with mineral oil after assembly. If the presence of oil is detrimental to the process, it can be flushed out with a solvent before mounting. If critical, the pump must be completely disassembled to make sure that all traces of oil are removed. Flushing should be done by hand; the pump should not be power driven during the flushing operation.
2. If flushing is necessary, it is strongly recommended to then lubricate the pump with a substance which is compatible with the process or with the process fluid itself.
3. Once the pump is mounted, ensure that the pump turns freely by hand. Alignment of the pump shaft with the shaft from the drive system is critical. The coupling should allow a certain amount of misalignment. There must be spaces between the pump shaft, coupling and drive system shaft in the axial direction, because there will almost certainly be movement of the various components during heating and some space must be left for this movement. No overhung or side loads should be applied to the pump shaft. In pumps with a through shaft and compression packing seal, the pump-to-driver axis may shift unevenly due to pump heating expansion. To remedy this, we recommend connecting the pump driver to the pump shaft with the appropriate Zenith SJM Coupling or with a double universal joint arrangement. This type of joint will prevent bending loads from being transmitted to the pump shaft when misaligned. This greatly reduces the possibility of premature shaft failure due to fatigue. To prevent seizure, be sure to apply adequate high-temperature lubrication to the universal joints.
4. Always be sure the pump can turn freely by hand prior to start-up.

Installation (continued)

5. Filters should be installed upstream of the pump inlet and should filter ideally to half the pump running clearances.
 6. Heat the pump thoroughly and evenly (including the seal arrangement). A time-saving heating alternative would be to maintain a clean and ready-to-use pump in an oven at operating temperature. This avoids thermal shock and saves valuable heating time. Be sure to check the packings prior to use as extended heat soaks tend to dry out some packing materials.
 7. Make sure the pump is primed before starting. Be sure to apply positive inlet pressure when metering high-viscosity fluids.
 8. With a pump having a packing seal, take up firmly and evenly on the seal gland screws to compress the packing, then back off 1/2 turn of the screws or until slight weepage occurs. Be sure to adjust the gland properly. Do not overtighten. Overtightening can cause the packings to burn. Be sure to follow up closely throughout the running-in period of the packing until the seal is thoroughly seated. Do not completely seat the packing in one adjustment.
- pressure allowing time to ensure that process fluid has filled the pump.
2. Before starting, remove all flow restrictions downstream of the pump to allow initial operation with as low a back pressure as possible.
 3. Start the pump at the slowest speed possible and if possible, with a lubricating fluid. Watch the point of discharge for evidence of fluid. If no discharge is seen after a reasonable length of time, shut the pump off and check for obstructions in the system and proper pump rotation. The term "sufficient length of time" is subjective, and cannot be quantified because of differences in installations. If, for example, a connection can be broken within a few inches of the pump outlet port, the flow would be evident within several seconds. If the distance between the pump outlet and the point of final discharge is long, more time would be needed before flow is confirmed.
- Listen for sounds of distress when first starting the pump and turn the pump off immediately if any are heard. Investigate for causes of distress.

Startup

1. Allow enough time for all components of the system to reach process temperature before starting the pump. If necessary, apply inlet
4. If the pump is operating satisfactorily at low-speed and low-load conditions, slowly increase the speed to that of full operation and then slowly apply full operational pressure.
5. Never allow the pump to run dry.

Cleaning, Inspection and Repair

REMEMBER: Zenith metering pumps are made for exacting duty. In order to develop high pressure and minimize slip, the clearance between the metering gears and their housing must be as small as possible, yet large enough to allow adequate lubrication. All parts are machined to extreme accuracy. Critical dimensions are held between one and two ten-thousandths of an inch (.0001"/.0002"). Accurate performance is dependent upon proper handling. Please handle the pumps with extreme care, and if possible, set aside a separate clean area for pump maintenance and repair.

After the pump has been in service for a period of time, there usually comes a time when the pump must be disassembled for routine maintenance, cleaning or other reasons. The pump normally has to be cleaned to allow ease of disassembly. This can range anywhere from simply flushing the pump, to a vacuum oven burnout at a maximum temperature of 800°F in a protective atmosphere. Soak the pump in solvent (TEG for example for polyester) or heat to a moderate temperature of 300° to 600°F to melt the process fluid and allow most of it to run out of the pump. If a vacuum oven is available, the pump may be heated to higher temperatures to carbonize the polymer within the pump. Contact the factory for proper burnout temperatures. In some cases, disassembly can be facilitated by applying one of the several available penetrating oils by spraying or soaking. Once cleaned, the pump is ready for disassembly.

To clean H-9000 Series metering pumps used for polymer service, place them in a suitable furnace and gradually heat them in an inert atmosphere for the initial hour to prevent flashing of the polymer. Time at temperature will be related to the pump size and the degree of polymer contamination and should be determined by trial.

NOTE: Careful control of the furnace temperature and atmosphere is critical. Should the temperature

exceed the original tempering temperature, the steel hardness will draw back and the dimensional stability of the pump may be upset.

Another acceptable cleaning method is to immerse the pump in a fluidized bed cleaning bath. The bath should be heated to a temperature that is sufficient to carbonize the polymer. The carbonization process usually takes between 3 to 12 hours, depending on the polymer type, temperature, pump size and furnace load.

CAUTION: Avoid exposing the pump to thermal shock when using this method of cleaning.

After gradually cooling to room temperature, the pump should be thoroughly flushed in a clean solvent. It may be necessary to disassemble the seal arrangement to remove polymer ash.

It is recommended that pump users institute a program of dimensional inspection of critical parts in order to keep maintenance and operating costs at a minimum. By noting the performance of a pump immediately before removing it from service and correlating the performance to measured component wear, the user can establish the maximum wear limits for the pump's critical components. Further, he can predict the service life of the pump, and schedule his down-time accordingly.

As with all Zenith pumps, H-9000 Series pumps may be returned to Zenith for complete rehabilitation as necessary. This procedure may be desirable if only a few pumps are involved. If a large number of pumps are to be maintained at the user's plant, it may be worthwhile to have key personnel attend a maintenance seminar at Zenith to view the manufacturing, gaging and assembly techniques involved in producing the H-9000 Series pump. In addition, Zenith also offers a contract service program. Please contact Zenith for further information on these items.

.3-2.4 cc/rev H-9000

Interpret per
ANSI-Y14.5M 1982

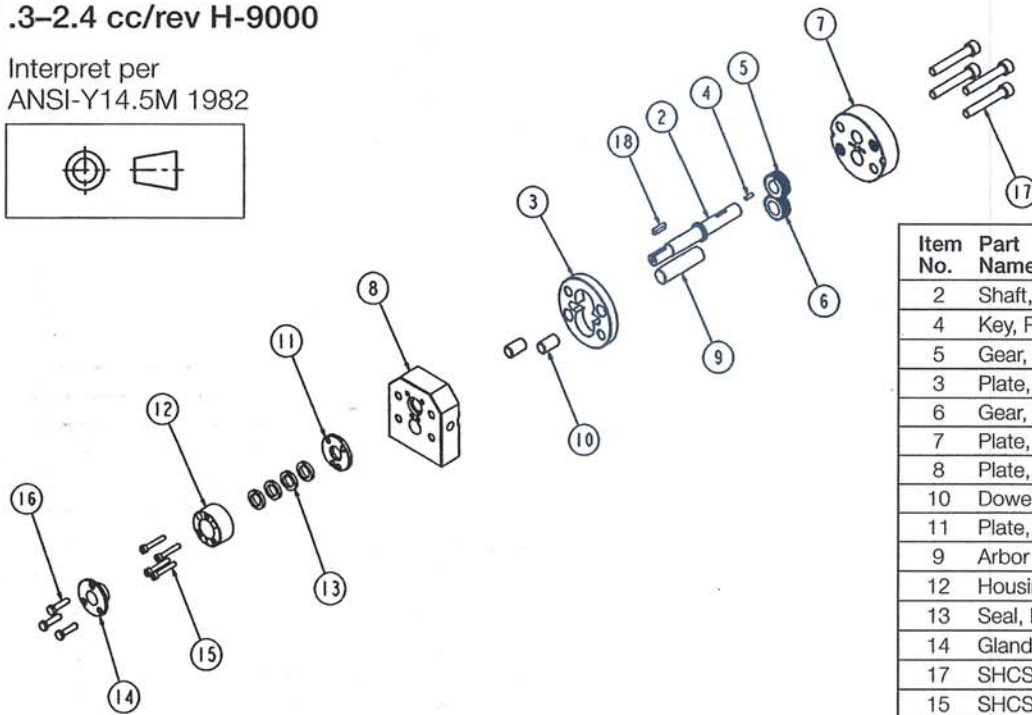
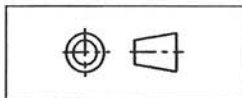

Item No.	Part Name
2	Shaft, Drive
4	Key, Round
5	Gear, Driving
3	Plate, Gear
6	Gear, Driven
7	Plate, Rear
8	Plate, Front
10	Dowel, Hollow
11	Plate, Collar
9	Arbor
12	Housing, Packing
13	Seal, Packing
14	Gland, Packing
17	SHCS M8X1.25 X 50MM Alloy 12.9
15	SHCS M4X0.7 X 25MM Grade 12.9
16	HHCS M5X0.8 X 20MM Alloy Grade 8.8
18	Key, Square w/Rnd Ends

4.5 & 9 cc/rev H-9000

Interpret per
ANSI-Y14.5M 1982

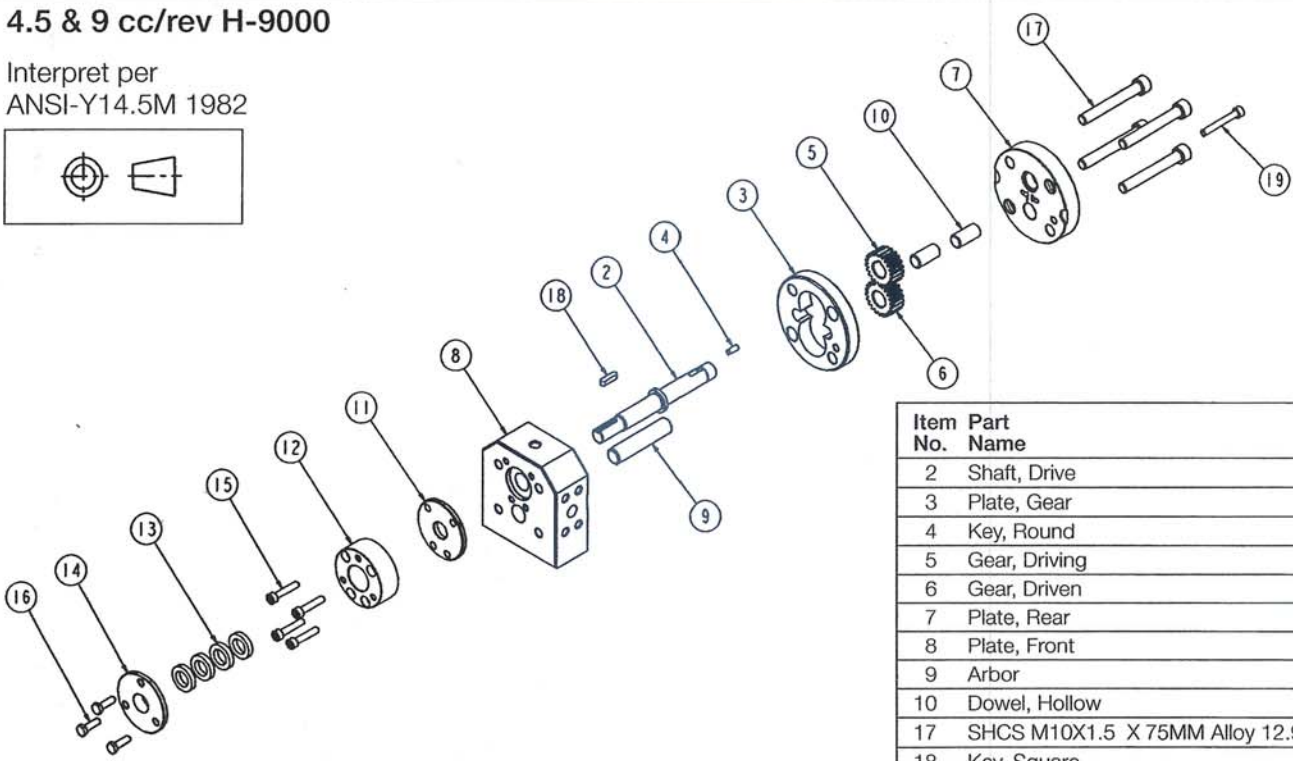
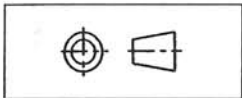

Item No.	Part Name
2	Shaft, Drive
3	Plate, Gear
4	Key, Round
5	Gear, Driving
6	Gear, Driven
7	Plate, Rear
8	Plate, Front
9	Arbor
10	Dowel, Hollow
17	SHCS M10X1.5 X 75MM Alloy 12.9
18	Key, Square
19	SHCS M6X1 X 45MM Alloy 12.9
11	Plate, Collar
13	Seal, Packing
14	Gland, Packing
16	HHCS M6X1 X 20MM Alloy Grade 8.8
12	Housing, Packing
15	SHCS M6X1 X 30MM Alloy 12.9

For example only. See certified drawing for specific capacities.

15 & 30 cc/rev H-9000

Interpret per
ANSI-Y14.5M 1982

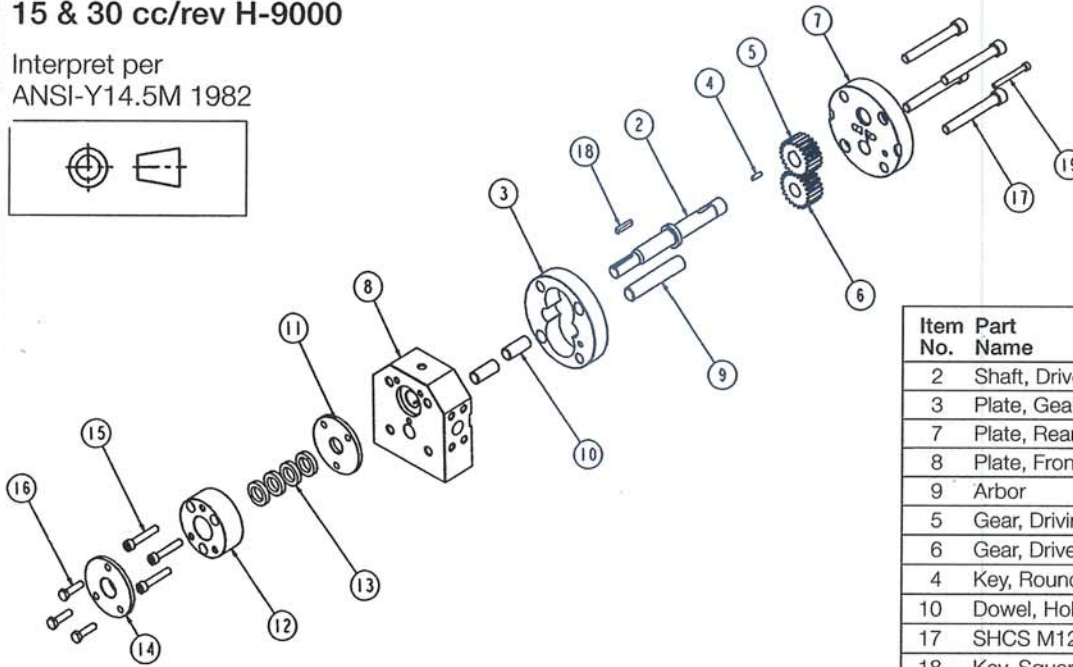
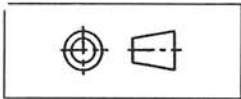

Item No.	Part Name
2	Shaft, Drive
3	Plate, Gear
7	Plate, Rear
8	Plate, Front
9	Arbor
5	Gear, Driving
6	Gear, Driven
4	Key, Round
10	Dowel, Hollow
17	SHCS M12X1.75 X 90MM Grade 12.9
18	Key, Square
11	Plate, Collar
12	Housing, Packing
13	Seal, Packing
14	Gland, Packing
15	SHCS M8X1.25 X 45MM Alloy 12.9
16	HHCS M8X1.25 X 30MM Alloy Grade 8.8
19	SHCS M6X1 X 55MM Alloy 12.9

45 & 90 cc/rev H-9000

Interpret per
ANSI-Y14.5M 1982

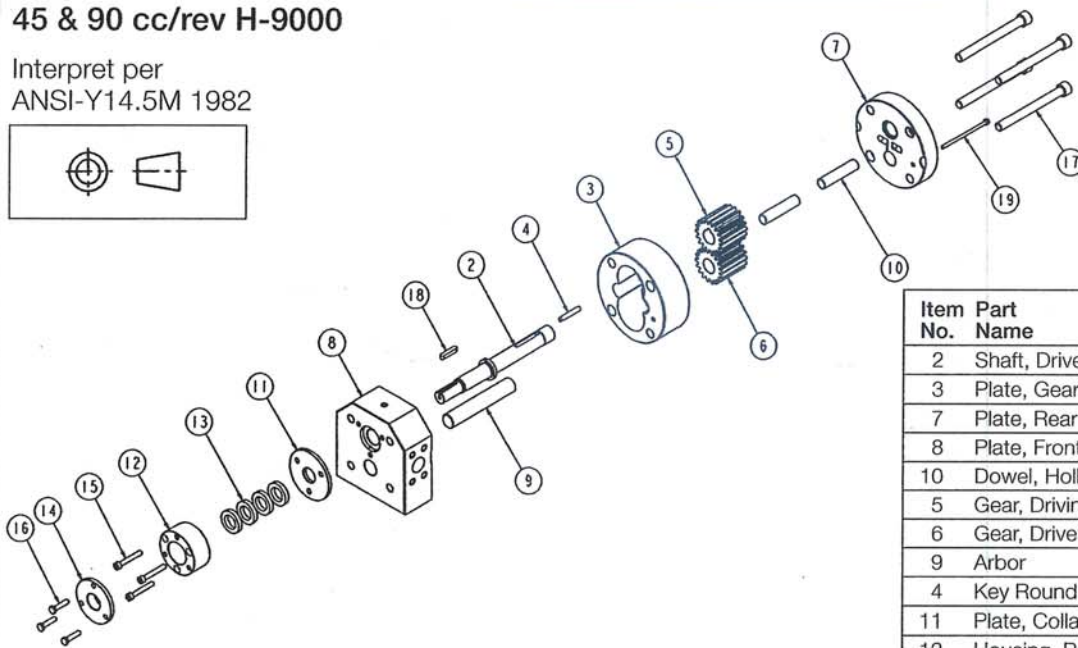
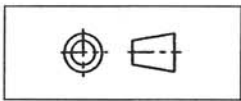

Item No.	Part Name
2	Shaft, Drive
3	Plate, Gear
7	Plate, Rear
8	Plate, Front
10	Dowel, Hollow
5	Gear, Driving
6	Gear, Driven
9	Arbor
4	Key Round
11	Plate, Collar
12	Housing, Packing
13	Seal, Packing
14	Gland, Packing
16	HHCS M8X1.25 X 35MM Alloy Grade 8.8
15	SHCS M8X1.25 X 55MM Alloy 12.9
17	SHCS M16X2 X 160MM Alloy 12.9
18	Key, Square
19	SHCS M6X1 X 110MM Alloy 12.9

For example only. See certified drawing for specific capacities.

Lapping or Blocking

To remove nicks, burrs and scour marks from pump parts, place two layers of 400-Grit Emery Cloth on a lapping block or plate. A granite flat is also suitable. Apply light pressure to the part and turn it using a figure 8 motion approximately ten times until a smooth finish appears. Areas that are commonly lapped are the sides of metering gears and the inside faces of front, gear and rear plates. After lapping is completed the parts are ready to be cleaned with a safe industrial solvent.

Always use clean, lint-free rags and compressed air to clean compo-

nents. Paper towels are not acceptable because they can leave small pieces of paper and dust on the pump parts. Use chemical brushes to clean between gear teeth, bores and reliefs. After all components are "hospital clean," the pump can be reassembled.

If cleaned parts are not to be reassembled for a period of time, they should be coated with a rust preventative fluid, such as mineral oil, to prevent rusting.

New and replacement parts should always be deburred and cleaned using the above procedures.

H-9000 Series Disassembly

Note: As parts are disassembled, place them carefully on a clean surface such as a soft cloth. Do not allow them to knock together. Pay close attention to the order in which parts are removed. This will aid in the reassembly of the pump.

1. Remove the square key (18).
2. Remove the hex head screws (16) from the packing gland (14).
3. Lift off the packing gland (14).
4. Remove the socket head screws (15) from the packing housing (12).
5. Lift off the packing housing (12).
6. Remove the seal packing rings (13) from the inside of the packing housing (12).
7. Remove the collar plate (11).
8. Loosen and remove the socket head screws (17) and (19) from the back of the rear plate (7).
9. Remove the rear plate (7). Always use the pry slots to prevent scratching the plates!
10. Lift off the gear plate (3). Always use the pry slots to prevent scratching precision lapped surfaces. **Caution:** Do not allow metering gears to be lifted out with the gear plate. They may drop, causing damage to the gear teeth.
11. Remove the driving gear (5) from the drive shaft (2) by turning and lifting simultaneously. Never use pliers to lift gears. Never use a screwdriver to pry gears upward.
12. Remove the round key (4).
13. Remove driven gear (6) from the arbor (9) by turning and lifting simultaneously.
14. Remove the drive shaft (2).
15. Remove the dowels (10) from the front plate (8) or rear plate (7) by turning and lifting simultaneously.
16. If the arbor (9) is to be replaced or thoroughly checked, press out by using an arbor press, pressing toward the inside of the pump (the shortest press distance).

Inspection and Part Preparation

After the parts have been cleaned, they should be inspected for nicks and burrs and stubborn residue. The gears and the edges of the gear plate gear pockets are the most likely areas to be damaged because of the sharp edges. An illuminated magnifier facilitates the examination.

1. All flat surfaces of plates and gears should be "blocked." Blocking is the act of rubbing the flat surface of a part on 400-grit, 500-grit or 3/0 abrasive paper, which is supported on a machinist's or inspector's surface plate. A few light but firm rubs usually are enough to remove residue and minor metal disturbances. *Remember to use a figure 8 pattern to retain flatness and perpendicularity of holes when lapping plates.*

Heavy disturbances or residue on front or rear plates (NOT the gear plate!) may require stronger blocking on 320-grit or even 240-grit abrasive paper followed by blocking on a finer abrasive paper. Deep score marks or metal transfer cannot be removed by blocking, and the surfaces must be ground. When surfaces are ground, care must be taken to maintain the perpendicularity of the

precision ground holes with the inner plate surface. The gear plate should never be ground; to do so would reduce the axial gear clearance to the point where interference might occur when the pump is reassembled. Gears can be ground as well, but interchangeability and clearances are altered. Grinding gears is *NOT* recommended!

2. Gears, shafts and arbors should be lightly polished on the O.D.
3. Any nicks in the gear teeth should be removed by carefully stoning the parts with a fine India oilstone or an Arkansas stone.
4. The edges of the gear's I.D., bearing holes and dowel holes should be lightly stoned with a round Arkansas stone to remove any nicks. Then polish the I.D. with a small piece of fine abrasive paper 400-grit or finer.
5. After all preparation has been completed, remove the abrasive grain and loose residue in an ultrasonic cleaner or other suitable cleaning method. Abrasive grain is larger in size than the pump clearances.
6. At this point, dimensional inspection may be made if desired.

H-9000 Series Reassembly

Use both pages of the assembly drawing during the reassembly process to assure correct orientation of all parts.

NOTE: If the pump will not turn freely after each component is installed, then the last piece installed needs additional attention or replacement.

Provide a can of compatible lubricant, preferably SAE-50 motor oil or mineral oil. If the pump is to be used at temperatures greater than 100°C, lubricant should be chosen for high temperature service. Shaft, arbor, dowels, and gears should be lubricated prior to assembly. Take care to remove excess fluid from between the plate surfaces using a clean towel. Threads should be lubricated with a temperature-rated, anti-seize compound. For service under 100°C, a moly-disulfide-based grease may be used. During assembly, considerable care should be taken to prevent wedging or jamming of close-fitting components. Never force the parts together. They will drop into place if properly aligned.

1. Place the front plate (8) on a flat surface with the inner surface of the plate facing up.
2. If the arbor (9) was removed, press arbor into the front plate (8) using the driven gear (6) as a guide for pressing the arbor perpendicular (upright) into the plate.
3. Push the slip-fit dowels (10) into the dowel holes in the front plate (8).
4. Place the driven gear (6) on the arbor (9).
5. Place the gear plate (3) over the dowels (10) and driven gear (6). On .3 through 2.4cc models, the gear plate may be installed in either direction. On models larger than 2.4cc, align the clearance hole for the fastener (19) with the corresponding tapped hole on the front plate.
6. Install the drive shaft (2) from the opposite side of the front plate.
7. Install the round key (4) into the keyway on the drive shaft.

8. Slide the drive gear (5) onto the drive shaft and into the gear plate. Take care to align the keyway in the gear with the key (4). The key may need to be held down to prevent it from being damaged by the gear.
9. Install the rear plate (7).
10. Install the socket head screws (19) through the rear plate (7) and torque to 50% of recommended torque (see table page 13) using a crossing pattern. Check for free rotation of the gears. If acceptable, continue to torque to full recommended torque. Again, check for free rotation of the gears.
11. Install the socket head screw (20) through the rear plate (7) and torque to recommended value.
12. Install the collar plate (11) over the drive shaft (2).
13. Install new packing rings (13) in the packing housing (12).
14. Install the packing housing (12) over the drive shaft (2). Use the flat side of the packing gland (14) to push the housing into place, if necessary, to prevent the packings from being pushed out of the housing.
15. Use the packing gland (14) to slightly compress packing rings (13) and properly position the packing housing (12).
16. Remove the gland (14), taking care not to move the housing (12). Install the socket head screws (15) through the packing housing (12) and the collar plate (11) and tighten to the recommended torque.
17. Place the packing gland (14) into position over the packing housing (12).
18. Install the hex head bolts (16) through the packing gland (14) and tighten finger tight.
19. Install the square key (18) into the drive shaft keyway.

Screw Torque

Size (UNC Alloy Steel)	Recommended Torque (lbs.-in.)	Size (Metric Alloy Steel)	Recommended Torque (lbs.-in.)
#10-24	64	M3	19
#12-24	120	M5	85
1/4-20	150	M6	140
5/16-18	305	M8	350
3/8-16	480	M10	680
1/2-13	900	M12	1,200
5/8-11	1,600	M16	2,900
3/4-10	2,400		

Trouble-shooting

Possible malfunctions of the pump with their causes and remedies are listed in the following table.

Trouble	Probable Cause	Remedy
Pump will not turn	Process temperature too low	Check thermocouple and control loop for proper setting or operation.
	Drive malfunction	Verify that drive is powered. Assure that alarm circuits are clear. Check motor drive current and speed settings. Check drive couplings.
	Process conditions changed	Check process fluid for proper melt temperature.
	Entrained particle	Disassemble and clean pump; replace any damaged parts.
	Internal damage	Disassemble and clean pump; replace any damaged parts.
	Incorrect installation	Check mounting arrangement. Check evenness of heating.
	Lack of lubrication	Journal bearing design may not be adequate.
Reduced pump efficiency	Interference fit of moving part	Measure clearances and correct if possible.
	Worn gear(s)	Replace worn gear(s).
	Worn side plate(s)	Resurface or replace worn plate(s).
	Worn gear plate	Replace gear plate.
Seal leakage	Worn shaft and/or bearing holes causing excessive leakage	Replace shaft and/or side plates(s).
	Worn or damaged packing	Replace.

B

B

B



WARNING

FAILURE, IMPROPER SELECTION OR IMPROPER USE OF THE PRODUCTS AND/OR SYSTEMS DESCRIBED HEREIN OR RELATED ITEMS CAN CAUSE DEATH, PERSONAL INJURY AND PROPERTY DAMAGE.

This document and other information from Zenith Pumps, its subsidiaries and authorized distributors provide product and/or system options for further investigation by users having technical expertise. It is important that you analyze all aspects of your application and review the information concerning the product or system in the current product catalog. Due to the variety of operating conditions and applications for these products or systems, the user, through its own analysis and testing, is solely responsible for making the final selection of the products and systems and assuring that all performance, safety and warning requirements of the application are met.

The products described herein, including without limitation, product features, specifications, designs, availability and pricing, are subject to change by Zenith Pumps and its subsidiaries at any time without notice.

ISO 9001: 2000 Registered



Zenith® Pumps
5910 Elwin Buchanan Drive
Sanford, NC 27330-9551
Phone: 919-774-7667 • Fax: 919-774-5952
zenithpumps@colfaxcorp.com • www.zenithpumps.com